



Erzi® Qualitätsprodukte
aus Holz GmbH
Lengefelder Straße 16
D-09579 Grünhainichen
www.erzi.de

Pflege

Verwenden Sie Holzschutzmittel zur regelmäßigen Pflege und zum Schutz von imprägnierten Hölzern vor Witterungseinflüssen.
Wir empfehlen, die Pflege alle 1–2 Jahre nach Bedarf durchzuführen.
Achten Sie bitte auf umweltfreundliche Reinigungsmittel.

Product care

Use wood preservation for regular maintenance and protection from influences of dust, UV radiation and humidity of impregnated wood.
We recommend to maintain every 1-2 years as needed.
Please pay attention to using environmentally friendly detergents.

Entretien

Utiliser un produit de préservation du bois à protéger et à conserver du bois imprégnés contre les influences atmosphériques !
Nous vous recommandons d'exécuter les travaux d'entretien suivants à intervalles réguliers (tous les un ou deux ans, en cas de besoin).
Veillez à ce que les produits nettoyants soient écologiques.

Verzorging

Gebruik houtbeschermingsmiddelen voor een regelmatig onderhoud en ter bescherming van geïmpregneerde soorten hout tegen weersinvloeden. Wij adviseren, het onderhoud telkens na 1-2 jaar, al naar behoefte, uit te voeren.
Gelieve op milieuvriendelijke reinigingsmiddelen te letten.

Cura

Utilizzare preservanti del legno adatti alla cura periodica e alla protezione del legno impregnato dagli agenti atmosferici. Si consiglia di ripetere la cura ogni 1-2 anni, a seconda delle necessità.
Si prega di prestare attenzione ai detersivi ecocompatibili.

Cuidado

Use conservantes de madera apropiados para el cuidado periódico y la protección de la madera impregnada contra las influencias atmosféricas. Recomendamos repetir el tratamiento cada 1-2 años según sea necesario.
Utilice productos de limpieza respetuosos con el medio ambiente.



10052

Aufbauanleitung Spielküche Outdoor
Assembly instructions Outdoor Play Kitchen
Instructions de montage Cuisine de Jeu Outdoor
Handleiding Speelkeuken Outdoor
Istruzioni Cucina da gioco Outdoor
Instrucciones Cocina de juguete Outdoor

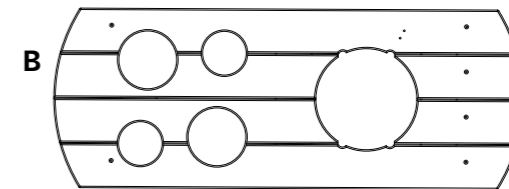
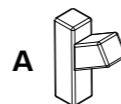
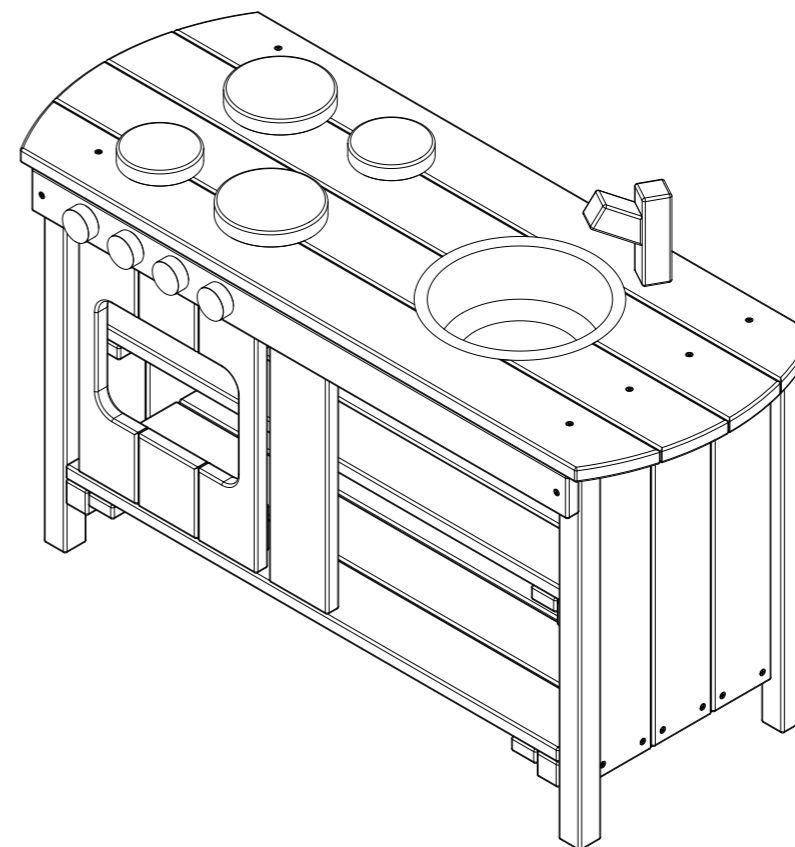

Sie benötigen | You need
Vous pouvez | Je hebt nodig
Hai bisogno | Usted necesita

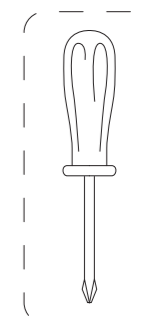

28x

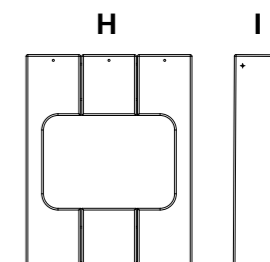
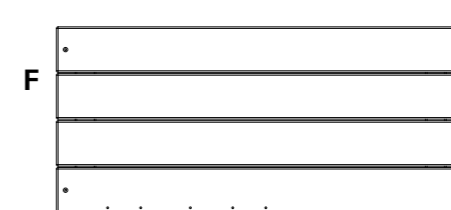
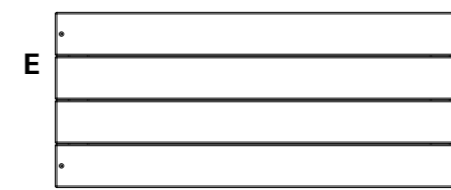
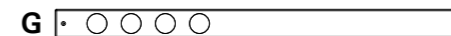
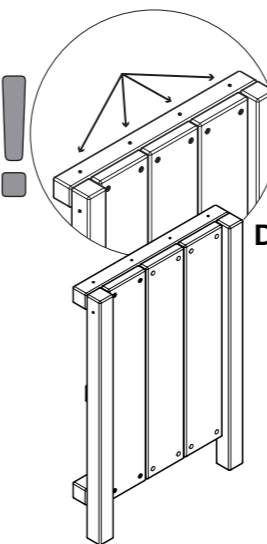
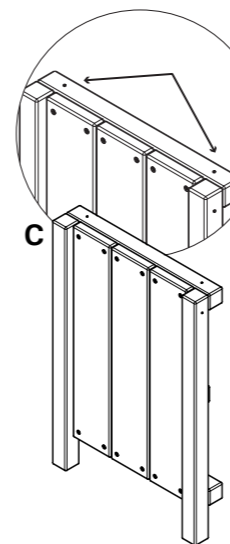

**Auf-, Um- und Abbau nur durch Erwachsene
Nur unter Aufsicht verwenden! Nicht draufsetzen!**

**Installation, assembly and dismantlement may only be carried out by adults
Use only under supervision! Do not sit on it!**

Seuls des adultes sont en droit de procéder à l'assemblage, à la transformation et au démontage. Utilisez uniquement sous surveillance! Ne pas s'asseoir an-dessus!

**Montage, ombouw en demontage alleen door volwassenen.
Alleen onder toezicht gebruiken! Niets erop zetten!**

Montaggio, trasformazione e smontaggio devono essere effettuati solo da parte di adulti. Usare solo sotto la supervisione di adulti! Non sedersi sopra!

**El montaje, instalación o desmontaje solo puede ser realizado por adultos.
¡ Utilizar solo bajo la supervisión de adultos! ¡No sentarse encima!**



Herstellernachweis bitte aufbewahren.

Please keep manufacturer's reference.

Conserver l'identification du fabricant.

